



HVAC SYSTEM COMPONENTS

Red Dot **Replacement Parts**

**SCHOOL AND TRANSIT BUSES**

# BUS HVAC Parts





# Bus HVAC Parts

Here's a comprehensive list of everything you'll need to service the buses that come into your shop for maintenance of their heavy-duty HVAC systems. We provide cross reference for OEM parts from Bluebird, Carrier/MCC, Thomas Built and Trans/Air.

## CROSS REFERENCE

OEM Part No.	Red Dot Part No.	OEM Part No.	Red Dot Part No.	OEM Part No.	Red Dot Part No.	OEM Part No.	Red Dot Part No.
<b>BLUEBIRD</b>				<b>CARRIER/MCC</b>			
<b>BLOWER WHEEL</b>		<b>FAN ASSEMBLY</b>		<b>BLOWER WHEEL</b>		<b>FITTING ADAPTER</b>	
00033722	73R7130	11-00059	RD-5-8705-0P	38-00564-50	73R7220	501-218	75R8520
<b>COMPRESSOR</b>		<b>RECEIVER DRIER</b>		<b>CLUTCH</b>		<b>EXPANSION VALVE</b>	
20-10089	75R84472	00084864	74R1756	17-31252-00	75R0082	101-100	71R8301
20-10089	75R81502	37-10870	74R0462	17-31253-00	75R4782	101-101	71R8050
<b>EXPANSION VALVE</b>		<b>RELAY</b>		17-31262-00	75R4792	101-102	71R8100
0015318	71R8301	00090192	71R1702	501-291	75R0082	20-210019	71R8321
00063509	71R8380	04300026	71R1702	501-292	75R0262	<b>FITTING</b>	
<b>HEATER CORE NIPPLE</b>		<b>RESISTOR</b>		501-293	75R0252	301-409	70R2402
013240124	70R7100	00035868	71R1457	501-294	75R0274	301-410	70R2038
<b>KNOB</b>		1601681	71R1457	502-212	75R1432	301-412	70R2018
01494897	71R4105	4316295	71R1463	<b>COMPRESSOR</b>		301-413	70R2011
<b>LOUVER</b>		<b>SOLENOID VALVE</b>		17-31244-00	75R8672Q	301-414	70R2012
00090180	72R3135	00090197	71R9002	17-31248-00	75R8682Q	301-418	70R4498
<b>MOTOR</b>		<b>SWITCH</b>		18-00093-00	75R8422	301-419	70R4698
00035861	73R4312	04320925	71R1165	18-00093-02	75R81482	301-424	70R4396
0057157	73R0142	04320925	71R1160	18-00093-02	75R8462	301-426	70R4298
00104121	73R0142	08303141	71R1150	18-00093-04	75R84232	301-432	70R2408
00114540	73R0652	19-00335	71R1165	18-00093-04	75R81282	301-433	70R4696
0228072	73R0652	29-21901	71R1150	18-00093-05	75R8702Q	301-444	70R2406
1438480	73R0082	<b>THERMOSTAT</b>		18-00093-07	75R8712Q	301-447	70R4608
04316246	73R0642	00063511	71R3160	18-00093-13	75R85102Q	301-450	70R2016
08304610	73R4162	00090190	71R3220	18-00093-14	75R89462	301-455	70R2036
<b>MOTOR BLOWER ASSEMBLY</b>		<b>WATER VALVE</b>		18-10123-05	75R86144	301-462	70R4496
0086033	73R5502	020140100	72R5500	18-60012-11	75R8682Q	301-463	70R4406
0105366	73R5552			501-200A	75R81702	301-464	70R4606
				501-266	75R85332Q	301-473	70R4491
				501-266A	75R85332Q	301-482	70R4408
				501-268A	75R86152Q	302-432	70R4691
				501-268A	75R86172Q	302-436P	70R2072S
				501-271A	75R8512Q	302-437P	70R2071S
				501-275A	75R8614Q	313-176	70R4691
				501-276A	75R8702Q	313-177	70R4698
				501-282A	75R81582	313-178	70R4491
				501-282A	75R8432	313-179	70R4608
				501-289A	75R84582	313-184	70R2408
				501-289A	75R81512	313-185	70R4498
				501-289B	75R84582	313-189	70R4701S
				501-289B	75R81512	313-195	70R2072S
				501-298	75R84472	313-197	70R2071S
				501-298	75R81502	313-208	70R4408
				502-209	75R85932Q	313-212	70R4696
				502-210	75R8702Q	313-219	70R4496
				502-210A	75R8702Q		
				502-214A	75R81252		

# SCHOOL AND TRANSIT BUSES REPLACEMENT PARTS

## CROSS REFERENCE

OEM Part No.	Red Dot Part No.	OEM Part No.	Red Dot Part No.	OEM Part No.	Red Dot Part No.	OEM Part No.	Red Dot Part No.
<b>FITTING</b>		<b>REFRIGERANT HOSE</b>		<b>THOMAS BUILT</b>		<b>TRANS/AIR</b>	
313-224	70R2402	301-101	78R0458	<b>ALL PURPOSE FANS</b>		<b>COMPRESSOR</b>	
313-231	70R4606	301-102	78R0451	5200-3268	73R9062	512041	75R8102
313-252	70R2018	301-103	78R0452	<b>BLOWER WHEEL</b>		512048	75R8502Q
313-253	70R2011	311-007	78R0458	8566-0050	73R7130	512049	75R8502Q
313-254	70R2012	311-008	78R0451	<b>FILTER</b>		512059	75R84582
<b>MOTOR</b>		311-009	78R0452	85660643	78R5251	512059	75R81512
101-143	73R4102	<b>RELAY</b>		8566-0237	78R5256M	512068	75R8442
<b>MOTOR BLOWER ASSEMBLY</b>		201-804	71R1704	8566-0439	78R5236M	512074	75R8442
BLW-200-41	73R5772	221-568	71R1702	<b>MOTOR</b>		512075	75R85032Q
<b>O-RING</b>		221-711	71R1704	6600509	73R0142	512076	75R85032Q
518-002	70R5056	<b>SWITCH</b>		85660681	73R0032	512078	75R8442
518-002	70R5056	113-006	71R1150	2606-2365	73R0552	512080	75R81472
518-003	70R5058	201-300	71R1160	2606-5366	73R0142	512080	75R8382
518-003	70R5058	201-305	71R1165	6500-0439	73R0652	512085	75R84582
801-201	70R5056	<b>THERMOSTAT</b>		8566-0007	73R4182	512085	75R81512
801-201	70R5056	111-051	71R2300	8566-0009	73R4312	512086	75R8532Q
801-202	70R5058	18-00074-36	75R85632	8566-0102	73R4182	512089	75R84512
801-202	70R5058			8566-0226	73R0012	512097	75R84512
801-203	70R5051			8566-0227	73R0642	512108	75R81462
801-203	70R5051			8566-0297	73R4422	512119	75R8544Q
801-217	70R5052			8566-0378	73R0142	512120	75R8544Q
801-217	70R5052			8566-0447	73R4322	512125	75R85032Q
<b>FAN ASSEMBLY</b>				ABP N83 301051	73R0032	512129	75R8702Q
401-100	73R8712			ABP N83 301222	73R4312	512130	75r89302
MTR-105P	73R8722			ABP N83 301881	73R0142	512226	75r89302
MTR-140V	73R8712			BSM301252	73R4182	<b>EXPANSION VALVE</b>	
<b>PRESSURE SWITCH</b>				<b>RESISTOR</b>		210019	71R8321
201-402	71R6050			8566-0125	71R1457	210035	71R8400
201-407	71R6070					<b>FITTING</b>	
<b>RECEIVER DRIER</b>						313042	70R4698
101-302	74R2106					313093	70R4691
14-00203-00	74R0480					<b>MOTOR</b>	
14-00288-00	74R0480					101300	73R0142
14-01063-05	74R0485					<b>FAN ASSEMBLY</b>	
DRI-104	74R0475					2160080	RD-5-8705-0P
						<b>RECEIVER DRIER</b>	
						212010	74R0485
						212011	74R0907
						<b>RELAY</b>	
						112019	71R1704
						<b>SWITCH</b>	
						113006	71R1165
						<b>THERMOSTAT</b>	
						111051	71R2250

**ALL PURPOSE FANS**

**73R9062**

**RD-5-5796-0P**

12V, Metal Cage



**DOUBLE ENTRY BLOWER WHEELS**

**73R7130**

**RD-5-10346-0P**

4 3/4" diameter, 3 7/32" width  
 5/16" bore diameter  
 Hub inset: 1 1/16"  
 Clockwise Rotation  
 Plastic



**73R7220**

**RD-5-15298-0P**

4 1/2" diameter, 29" width  
 3/4" bore diameter  
 Hub inset: Flat  
 Steel

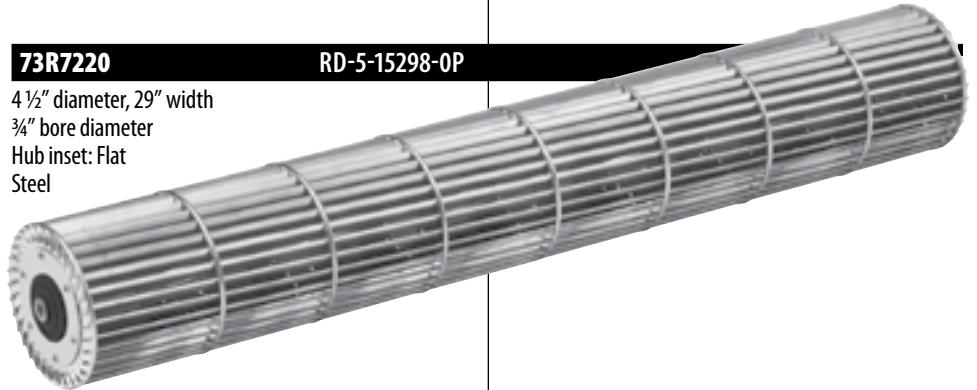

**BLOWER MOTORS**

**73R0012**

**RD-5-10379-0P**

Single Speed  
12 Volt  
Rotates Either Direction  
Stud Mounted, Span 2 5/16"  
Dimensions: 4" x 3 1/2" x 3"  
Shaft: 5/16" diameter, Length: 1 7/8"  
Vented  
Connector: Two conductor, 14 gauge



**73R0642**

**RD-5-10072-0P**

Single Speed  
12 Volt  
Rotates Clockwise  
Permanent Magnet Motor  
Stud Mounted, Span 2 5/16"  
Dimensions: 4 1/4" x 3 3/4" x 3"  
Shaft: 5/16" diameter, Length: 1 5/8"  
Vented  
Connector: Two conductors, 1/4" male & female spade



**73R0032**

**RD-5-10491-0P**

Two Speed  
12 Volt  
Rotates Clockwise  
Field Wound Motor  
Stud Mounted, Span 2 5/16"  
Dimensions: 3 5/8" x 2 3/4" x 3"  
Shaft: 1/4" diameter, Length: 1 1/16"  
Non Vented  
Connector: Ring Terminal, two conductor with ground



**73R0652**

**RD-5-10069-1P**

Two Speed – Economy  
12 Volt  
Rotates Clockwise  
Field Wound Motor  
Stud Mounted, Span 2 5/16"  
Dimensions: 4 9/16" x 3 5/8" x 3"  
Shaft: 5/16" diameter, Length: 1 5/16"  
Vented  
Connector: Two conductor, orange-high, red-low



**73R0082**

**RD-5-10071-0P**

Two Speed  
12 Volt  
Rotates Clockwise  
Field Wound Motor  
Stud Mounted, Span 2 5/16"  
Dimensions: 3 1/2" x 2 5/8" x 3"  
Shaft: 1/4" diameter, Length: 1 1/16"  
Non Vented  
Connector: Two conductor, orange-high, red-low



**73R4102**

**RD-5-3780-0P**

Three Speed  
12 Volt  
Field Wound Motor  
Strap / Stud Mounted, Span 2 5/16"  
Dimensions: 4" x 3 13/32" x 3"  
Shafts: 5/16" diameter, length: 3"  
Vented  
Connector: Four conductor  
1/4" female spade



**73R0142**

**RD-5-10070-0P**

Two Speed  
12 Volt  
Rotates Clockwise  
Field Wound Motor  
Stud Mounted, Span 2 5/16"  
Dimensions: 4 1/4" x 3 1/2" x 3"  
Shaft: 5/16" diameter, Length: 1"  
Vented  
Connector: Three conductor, two-speed, orange-high, red-low



**73R4162**

**RD-5-5190-0P**

Single Speed  
12 Volt  
Permanent Magnet Motor  
Stud Mounted, Span 2 5/16"  
Dimensions: 4 3/4" x 4" x 3"  
Shafts: 5/16" diameter, length: 2 1/2"  
Vented  
Connector: Two conductor spade terminal



**73R0152**

**RD-4183-0P**

Single Speed  
12 Volt  
Rotates Clockwise  
Field Wound Motor  
Stud Mounted, Span 2 5/16"  
Dimensions: 3 5/8" x 2 3/4" x 3"  
Shaft: 5/16" diameter, Length: 1 7/16"  
Non Vented  
Connector: One conductor, 14 gauge



**73R4182**

**RD-5-6801-0P**

Single Speed  
12 Volt  
Permanent Magnet Motor  
Strap / Stud Mounted, Span 2 5/16"  
Dimensions: 4 3/4" x 4" x 3"  
Shafts: 5/16" diameter, length: 2 1/2"  
Vented  
Connector: 1/4" spade receptacle



## BLOWER MOTORS

**73R4312**
**RD-5-10073-0P**

Single Speed  
 12 Volt  
 Permanent Magnet Motor  
 Stud Mounted, Span 2 5/16"  
 Dimensions: 5 3/8" x 4 1/2" x 3"  
 Shafts: 5/16" diameter, length: 2 13/16"  
 Vented  
 Connector: Two conductor 1/4" spade receptacle

**73R4422**
**RD-5-5049-1P**

Single Speed  
 12 Volt  
 Permanent Magnet Motor  
 Strap / Stud Mounted, Span 2 5/16"  
 Dimensions: 5 1/4" x 4 1/2" x 3"  
 Shafts: 5/16" diameter, length: 2 7/8"  
 Vented  
 Connector: Two conductor Packard #2984528  
 1/4" blade terminal

**73R4322**
**RD-5-10068-0P**

Single Speed  
 12 Volt  
 Permanent Magnet Motor  
 Stud Mounted, Span 2 5/16"  
 Dimensions: 4 7/8" x 4 1/2" x 3"  
 Shafts: 5/16" diameter, length: 2 1/2"  
 Vented  
 Connector: Two conductor spade receptacle



## BLOWER MOTOR ASSEMBLIES

**73R5502**
**RD-3-6770-0P**

Single Speed – 800 CFM – 12 volt  
 18 7/16" x 3" x 6 21/32"  
 Connector: Two conductor Packard terminal  
 #2984528

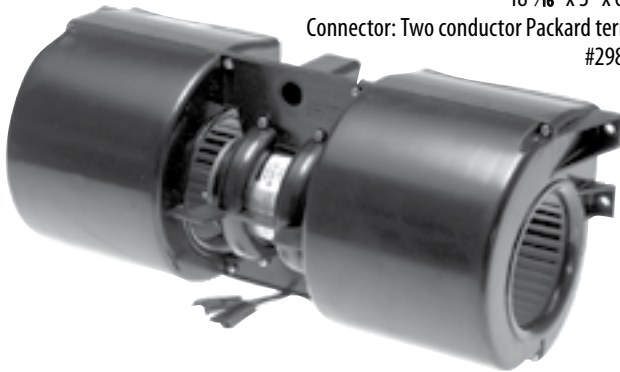
**73R5552 \***
**RD-5-8583-0P**

Three Speed – 619 CFM – 12 volt – 13 3/4" x 5 3/8" x 5 1/8"  
 Replacement Resistor 71R1402

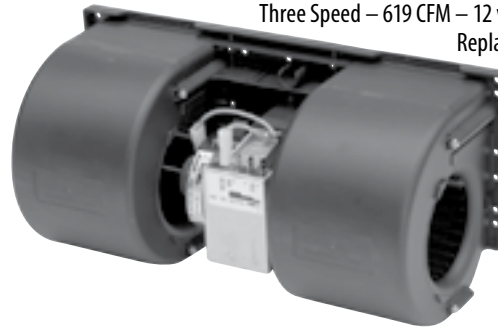

\* Operating temperature in working conditions must range between -4°F (-20°C) and +176°F (+80°C)



**COMPRESSOR CLUTCHES**

**75R0082**

**RD-5-10544-0P**

OE # 2570155  
 Model: Seltec - TM15  
 Diameter: 4 27/32" / 123mm  
 Groove: Poly 8  
 Width: .14"  
 12 Volts  
 B Dimension: 1 11/32" / 34 mm



Single wire coil  
 Male bullet plug



**75R0274**

**RD-5-10232-0P**

OE # 2570150  
 Model: Seltec - TM15  
 Diameter: 5 23/64" / 135mm  
 Groove: 2  
 Width: 1/2",  
 24 Volts  
 B Dimension: 1 9/16" / 40 mm



Single wire coil  
 Male bullet plug



**75R4792**

**RD-5-10302-0P**

OE # 2570168  
 Model: ICE - TM31  
 Diameter: 6" / 152mm  
 Groove: Poly 8  
 Width: .14  
 12 Volts  
 B Dimension: 2 5/8" / 67mm



Single wire coil  
 Male bullet plug



**75R0252**

**RD-5-10722-0P**

OE # 2570152  
 Model: Seltec - TM15  
 Diameter: 5 23/64" / 135mm  
 Groove: 2  
 Width: 1/2",  
 12 Volts  
 B Dimension: -



Single wire coil  
 Male bullet plug



**75R1432**

**RD-5-10361-0P**

OE#6593-6010  
 Model 709 / 7H15  
 Diameter: 4.9" / 125mm  
 Groove: Poly 8  
 Width: .14"  
 12 Volts  
 B Distance: -



Double wire coil  
 Ford OE plug



**75R0262**

**RD-5-10723-0P**

OE # 2570159  
 Model: Seltec - TM15  
 Diameter: 4.9" / 125mm  
 Groove: 2  
 Width: 1/2"  
 12 Volts  
 B Dimension: 1 9/16" / 40 mm



Single wire coil  
 Male bullet plug



**75R4782**

**RD-5-10301-0P**

OE # 2570165  
 Model: ICE - TM31  
 Diameter: 6" / 152mm  
 Groove: 2  
 Width: 1/2"  
 12 Volts  
 B Dimension: 3" / 76mm



Single wire coil  
 Male bullet plug



## COMPRESSORS

**75R8102 RD-5-5000-0P**

GMC A6R, Generic Superheat switch port  
 5" Single Groove Clutch – 12 volt  
 Pulley with ½" – ¾" variable groove R-12/R134a – no oil  
 Standard thread mounting holes Clockwise rotation

**75R81212 RD-5-10296-0P**

**Model:** 7H15 **Head:** GH **Voltage:** 12  
**Mount:** Direct **Sanden:** 4472  
**Clutch:** 5 ¼" (132mm) A2 Groove **R134a**

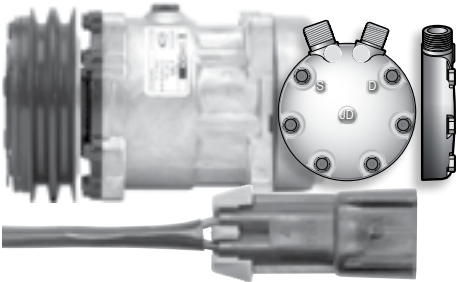
**75R81252 RD-5-11245-0P**

**Model:** 7H15 **Head:** WH **Voltage:** 12  
**Mount:** Direct **Sanden:** 4474, 7804  
**Clutch:** 4.7" (119mm) Poly 8 **R134a**

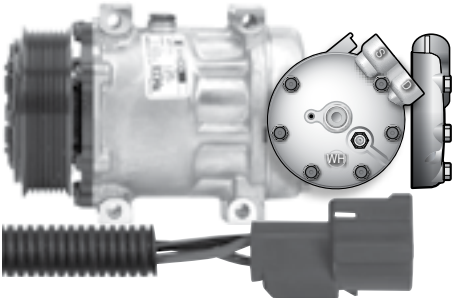
**75R81282 RD-5-11249-0P**

**Model:** 7H15 **Head:** MJ **Voltage:** 12  
**Mount:** Direct **Sanden:** 4776  
**Clutch:** 4.7" (119mm) Poly 8 **R134a**

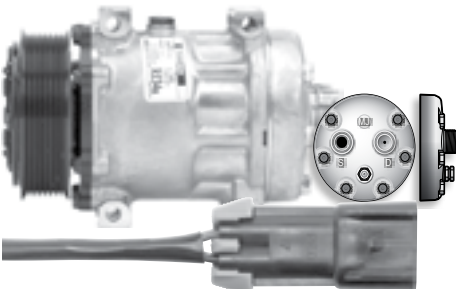
**75R81462 RD-5-11315-0P**

**Model:** SD7H15 **Head:** MDA **Voltage:** 12  
**Mount:** Ear **Sanden:** 4646  
**Clutch:** 5 ¼" (132mm) A2 Groove **R-134a**

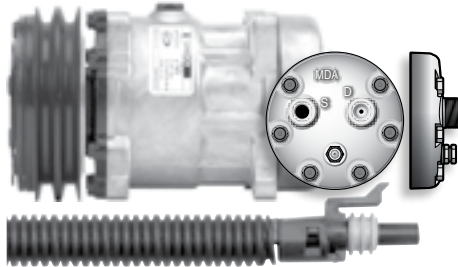
**75R81472Q RD-5-11316-1P**

**Model:** QP-7H15 **Head:** JDA **Voltage:** 12V  
**Mount:** Ear  
**Clutch:** 5" (125mm) 2 Groove **R134a**

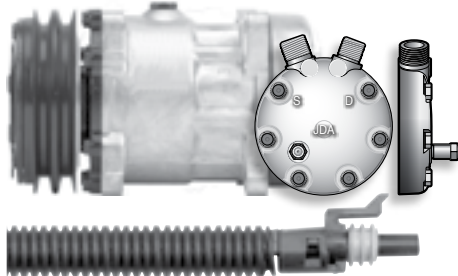
**75R81482 RD-5-11322-0P**

**Model:** 7H15HD **Head:** JDA **Voltage:** 12  
**Mount:** Ear **Sanden:** 4660  
**Clutch:** 4 ¾" (119mm) Poly 8 **R134a**

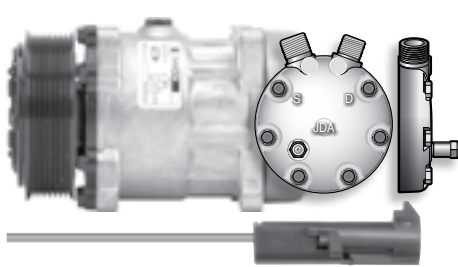
**75R81502 RD-5-11326-0P**

**Model:** 7H15 **Head:** KC **Voltage:** 12  
**Mount:** Direct **Sanden:** 4667  
**Clutch:** 4.7" (119mm) Poly 8 **R134a**

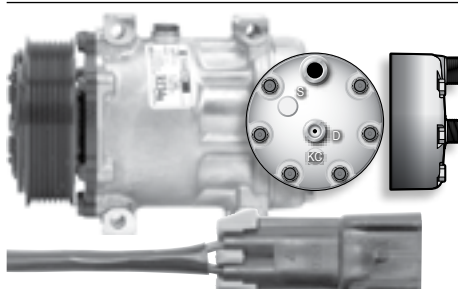
**75R81512 RD-5-11328-0P**

**Model:** 7H15 **Head:** MDA **Voltage:** 12  
**Mount:** Ear **Sanden:** 4672  
**Clutch:** 4.7" (119mm) Poly 8 **R134a**

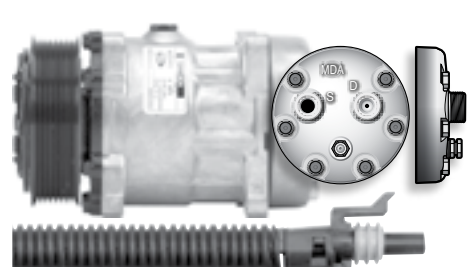
**75R81582 RD-5-11337-0P**

**Model:** 7H15HD **Head:** JD **Voltage:** 12  
**Mount:** Direct **Sanden:** 4780  
**Clutch:** 5 ¼" (132mm) A2 Groove **R134a**

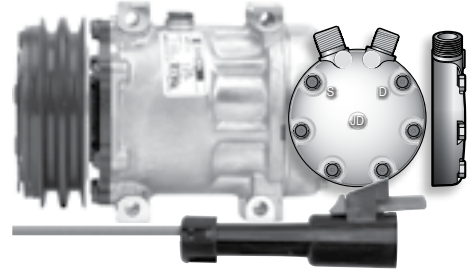
**75R8382 RD-5-11348-0P**

**Model:** 7H15 **Head:** JDA **Voltage:** 12  
**Mount:** Ear **Sanden:** 4510, 4664, 6664, 4639, 4644, 8104  
**Clutch:** 5 ¼" (132mm) A2 Groove **R134a**

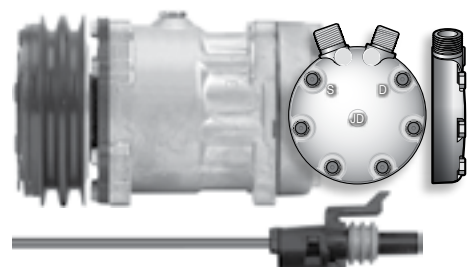

**75R8382 RD-5-7088-0P**

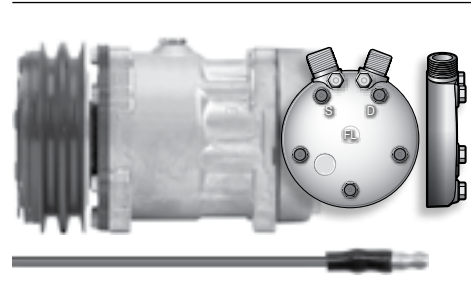
**Model:** 7H15 **Head:** FL **Voltage:** 12  
**Mount:** Ear **Sanden:** 4509, 4510, 6664  
**Clutch:** 5 ¼" (132mm) A2 Groove **R134a**

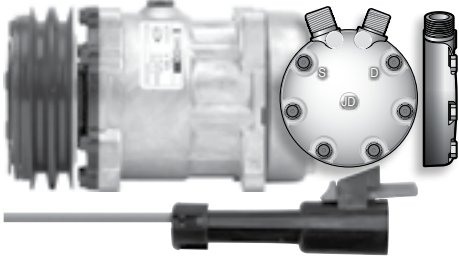

**COMPRESSORS**

**75R8422** RD-5-7120-0P  
**Model:** 7H15HD **Head:** JD **Voltage:** 12  
**Mount:** Ear **Sanden:** 4627  
**Clutch:** 4.9" (125mm) A2 Groove **R134a**



**75R84232** RD-5-10267-0P  
**Model:** 7H15HD **Head:** MDA **Voltage:** 12  
**Mount:** Direct **Sanden:** 4776  
**Clutch:** 4.7" (119mm) Poly 8 **R-134a**

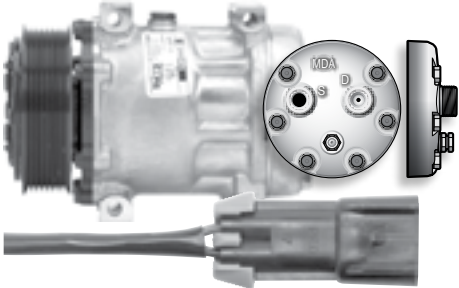

**75R8432** RD-5-7522-0P  
**Model:** 7H15HD **Head:** JDA **Voltage:** 12  
**Mount:** Direct **Sanden:** 4626, 4695  
**Clutch:** 5 1/4" (132mm) A2 Groove **R134a**

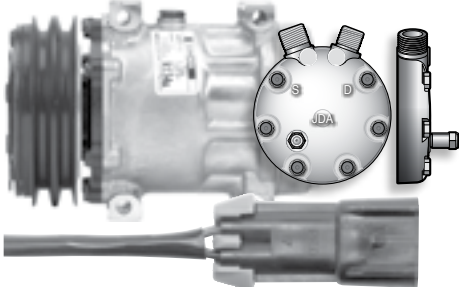

**75R8442** RD-5-7373-0P  
**Model:** 7H15 **Head:** MD **Voltage:** 12  
**Mount:** Ear **Sanden:** 7819  
**Clutch:** 4.9" (125mm) A2 Groove **R134a**

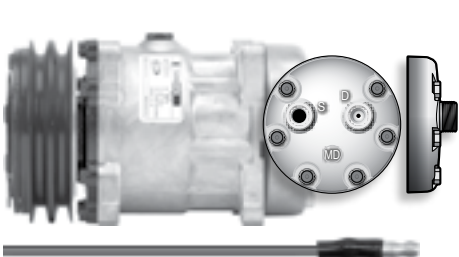

**75R84472** RD-5-10285-0P  
**Model:** 7H15 **Head:** KC **Voltage:** 12  
**Mount:** Direct **Sanden:** 4666  
**Clutch:** 4.7" (119mm) Poly 8 **R134a**

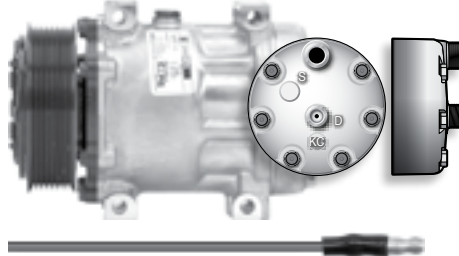

**75R84512** RD-5-10290-0P  
**Model:** 7H15 **Head:** JD **Voltage:** 12  
**Mount:** Direct **Sanden:** 4628, 8105  
**Clutch:** 4.7" (119mm) Poly 6 **R134a**

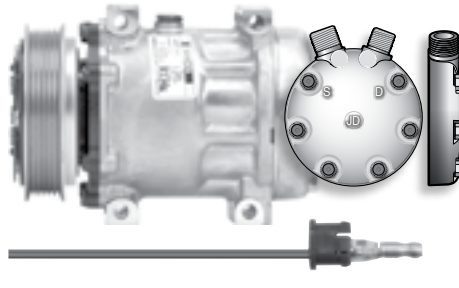

**75R8462** RD-5-9251-0P  
**Model:** 7H15 **Head:** JD **Voltage:** 12  
**Mount:** Ear **Sanden:** 4711, 8103  
**Clutch:** 4.7" (119mm) Poly 8 **R134a**

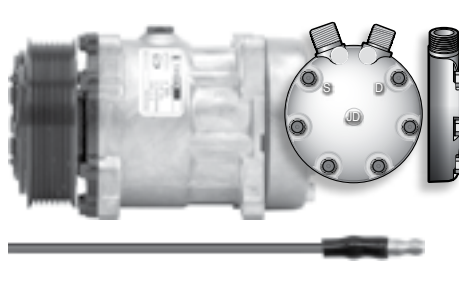

**75R8502Q** RD-5-5875-1P  
**Model:** QP-15HD **Head:** F **Voltage:** 12  
**Mount:** Ear **ICE:** 2521129 **Seltec:** 488-25063  
**Clutch:** 5" (125mm) 1 Groove overhang **R-12**

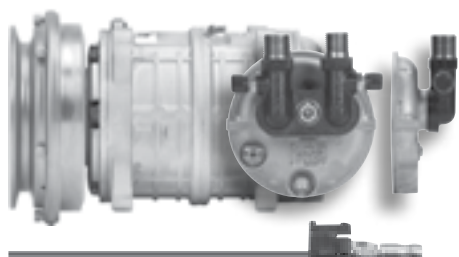

**75R85032Q** RD-5-9609-9P  
**Model:** QP-15HD **Head:** C **Voltage:** 12  
**Mount:** Ear **ICE:** 2521168 **Seltec:** 488-45075  
**Clutch:** 5" (125mm) 2 Groove **R134a**

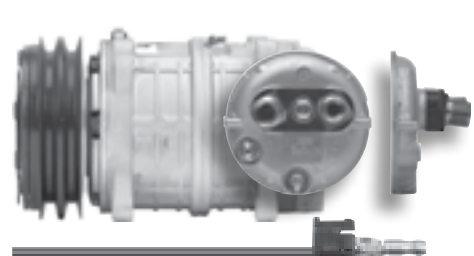

**75R85102Q** RD-5-12899-0P  
**Model:** QP-16HD **Head:** E **Voltage:** 12  
**Mount:** Direct (Tangential) **ICE:** 2521280 **Seltec:** 488-45082  
**Clutch:** 4 3/4" (123mm) Poly 8 **R134a**

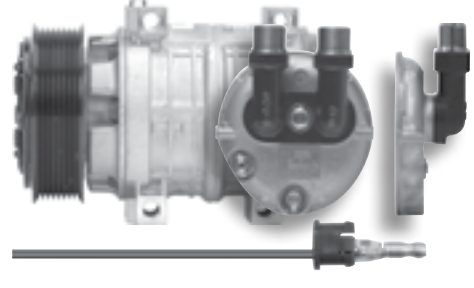

**75R8512Q** RD-5-5876-1P  
**Model:** QP-15HD **Head:** F **Voltage:** 12  
**Mount:** Ear **ICE:** 2521121 **Seltec:** 488-25011  
**Clutch:** 5 1/4" (135mm) 2 Groove **R-12**

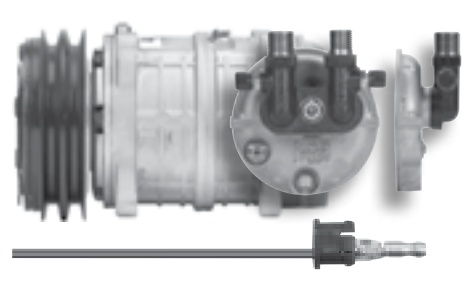

**75R8532Q** RD-5-8944-1P  
**Model:** QP-15HD **Head:** D **Voltage:** 12  
**Mount:** Ear **ICE:** 2521166 **Seltec:** 488-45063  
**Clutch:** 5" (125mm) 1 Groove overhang **R134a**

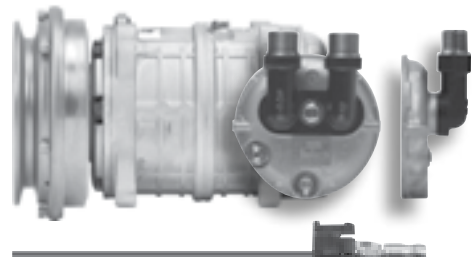

## COMPRESSORS

**75R85332Q** RD-5-10319-1P  
**Model:** QP-15HD **Head:** E **Voltage:** 12  
**Mount:** Ear **ICE:** 2521329 **Seltec:** 488-45094  
**Clutch:** 6 ¼" (159mm) 1 Variable Groove **R134a**

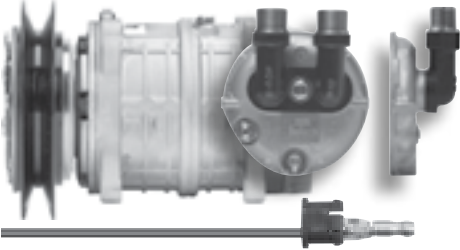

**75R8544Q** RD-5-9059-1P  
**Model:** QP-15HD **Head:** A **Voltage:** 24  
**Mount:** Ear **ICE:** 2521154 **Seltec:** 488-45017  
**Clutch:** 5 ¼" (135mm) 2 Groove **R134a**

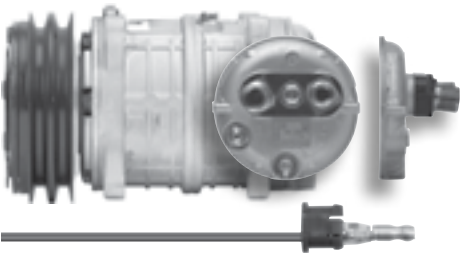

**75R85632Q** RD-5-10321-1P  
**Model:** QP-15HD **Head:** E **Voltage:** 12  
**Mount:** Ear **ICE:** 2521316 **Seltec:** 488-45023  
**Clutch:** 5 ¼" (135mm) 2 Groove **R134a**

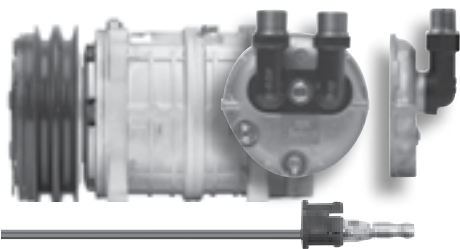

**75R85932Q** RD-5-10325-1P  
**Model:** QP-15HD **Head:** D **Voltage:** 12  
**Mount:** Ear **ICE:** 2521156 **Seltec:** 488-45019  
**Clutch:** 4 ¾" (123mm) Poly 6 **R134a**

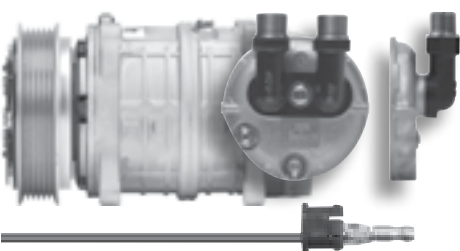

**75R86144Q** RD-5-11866-2P  
**Model:** QP-21HD **Head:** J **Voltage:** 24  
**Mount:** Direct **ICE:** 2521563 **Seltec:** 488-47246  
**Clutch:** 5 ½" (141mm) Poly 8 **R134a**

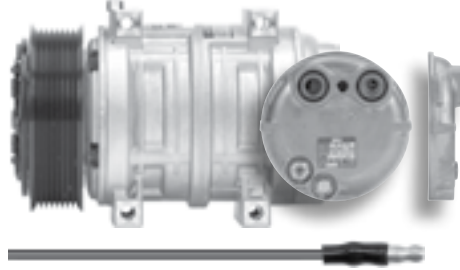

**75R8614Q** RD-5-7163-2P  
**Model:** QP-15HD **Head:** D **Voltage:** 24  
**Mount:** Ear **ICE:** 2521153 **Seltec:** 488-45015  
**Clutch:** 5 ¼" (135mm) 2 Groove **R134a**

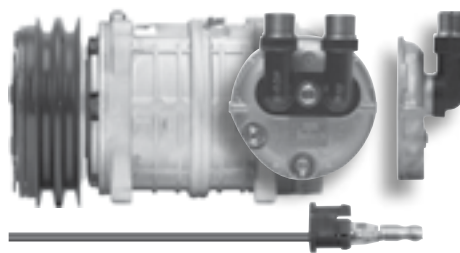

**75R86152Q** RD-5-10327-1P  
**Model:** QP-15HD **Head:** D **Voltage:** 12  
**Mount:** Direct (Tangential) **ICE:** 2521280 **Seltec:** 488-45082  
**Clutch:** 4 ¾" (123mm) Poly 8 **R134a**

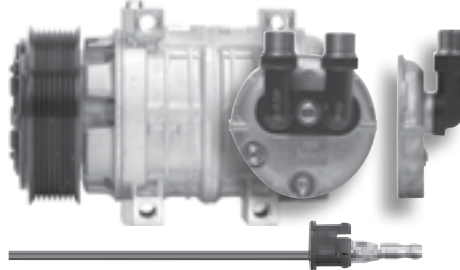

**75R86172Q** RD-5-10329-1P  
**Model:** QP-15HD **Head:** D **Voltage:** 12  
**Mount:** Direct (Tangential) **ICE:** 2521170 **Seltec:** 488-45088  
**Clutch:** 4 ¾" (123mm) Poly 6 **R134a**

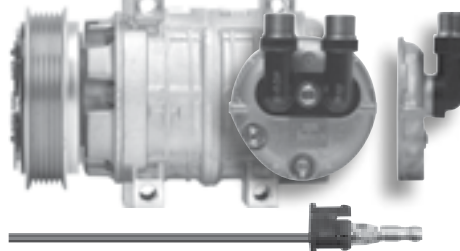

**75R8672Q** RD-5-12529-0P  
**Model:** QP-31HD **Head:** G **Voltage:** 12  
**Mount:** Direct (Tangential) **ICE:** 2521209 **Seltec:** 488-46500  
**Clutch:** 6" (152mm) 2 Groove, ½" **R134a**

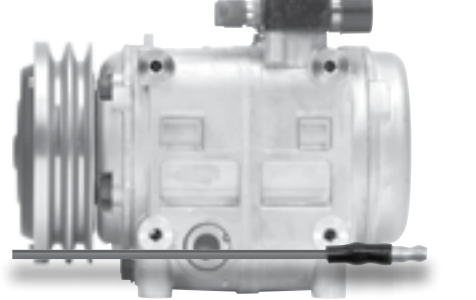

**75R8682Q** RD-5-12528-0P  
**Model:** QP-31HD **Head:** G **Voltage:** 12  
**Mount:** Direct (Tangential) **ICE:** 2521213 **Seltec:** 488-46540  
**Clutch:** 6" (152mm) Poly 8 **R134a**

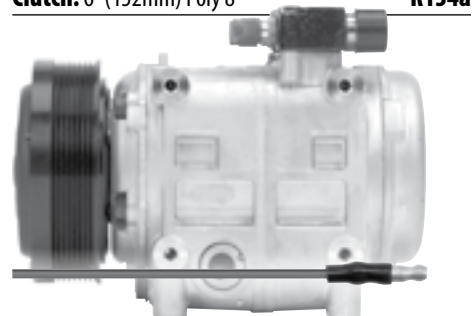

**75R8702Q** RD-5-10728-1P  
**Model:** QP-15HD **Head:** D **Voltage:** 12  
**Mount:** Ear **ICE:** 2521171 **Seltec:** 488-45120  
**Clutch:** 4 ¾" (123mm) Poly 8 **R134a**

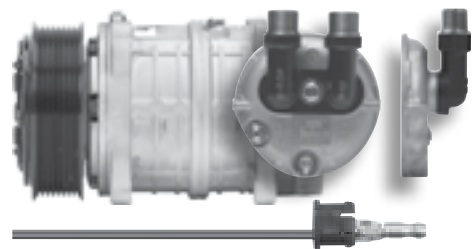

**75R8712Q** RD-5-9609-11P  
**Model:** QP-16HD **Head:** D **Voltage:** 12  
**Mount:** Ear **ICE:** 2521180 **Seltec:** 488-46011  
**Clutch:** 5 ¼" (135mm) 2 Groove **R134a**

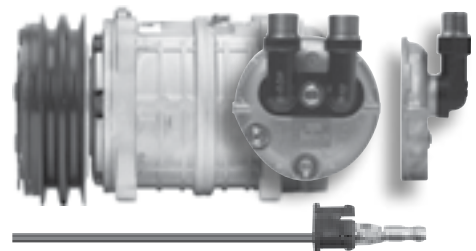

**COMPRESSORS**

**75R89302** RD-5-10885-0P  
**Model:** 7H15FLX **Head:** GV **Voltage:** 12  
**Mount:** Direct **Sanden:** 4420  
**Clutch:** 4.7" (119mm) Poly 8 **R134a**

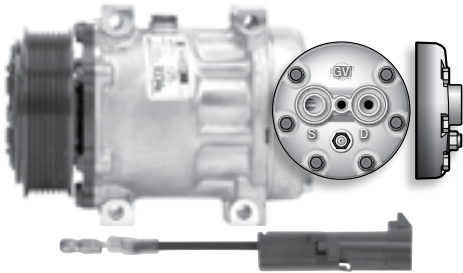

**75R89462** RD-5-11006-0P  
**Model:** 7H15FLX **Head:** GV **Voltage:** 12  
**Mount:** Direct **Sanden:** 4419  
**Clutch:** 4.9" (125mm) A2 Groove **R134a**

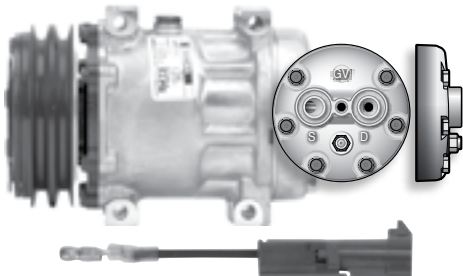

**FITTING ADAPTER**

**75R8520** RD-5-9156-0P  
**Head Type E**  
 Vertical Male O-Ring  
 1" X 14

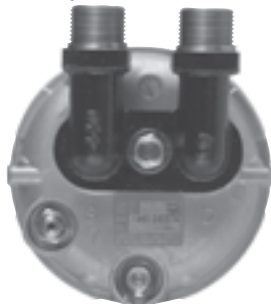

**EXPANSION VALVES**

**71R8050** RD-4126-1P

External Equalizer  
**Inlet:** #6 (3/8") Male Flare  
**Outlet:** #8 (1/2") Male Flare  
 Equalizer Tube  
**Length:** 18"  
**Nut:** 1/4" Female Flare  
**Capillary Tube Length:** 18"  
**Rating:** 1 1/2 Ton



**71R8100** RD-5-3824-1P

External Equalizer  
**Inlet:** #6 (3/8") Male O-Ring  
**Outlet:** #8 (1/2") Male O-Ring  
 Equalizer Tube  
**Length:** 13"  
**Nut:** 1/4" Female O-Ring  
**Capillary Tube Length:** 13"  
**Rating:** 1 1/2 Ton



**71R8301** RD-5-6868-0P

**Inlet:** #6 (3/8") Female O-Ring  
**Outlet:** #10 (5/8") Female O-Ring  
**Evaporator Fittings**  
**In:** #8 (1/2") Female O-Ring  
**Out:** #8 (1/2") Female O-Ring  
**Superheat Rating:** 5°F  
**Pressure Limit:** 80 psig @40°F

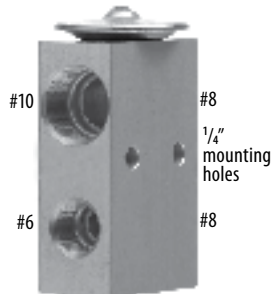

**71R8380** RD-5-9513-0P

Anti-trumpeting (2 Ton)  
**Inlet:** #6 (3/8") Female O-Ring  
**Outlet:** #10 (5/8") Female O-Ring  
**Evaporator Fittings**  
**In:** #8 (1/2") Female O-Ring  
**Out:** #10 (5/8") Female O-Ring  
**Superheat Rating:** 8°F  
**Pressure Limit:** 53.5 psig @75°F

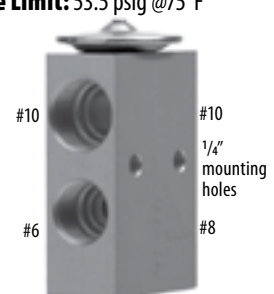

**71R8321** RD-5-7015-0P

High Capacity (2 Ton)  
**Inlet:** #6 (3/8") Female "O" Ring  
**Outlet:** #10 (5/8") Female O-Ring  
**Evaporator Fittings**  
**In:** #8 (1/2") Female O-Ring  
**Out:** #10 (5/8") Female O-Ring  
**Superheat Rating:** 8°F  
**Pressure Limit:** 53.5 psig @75°F

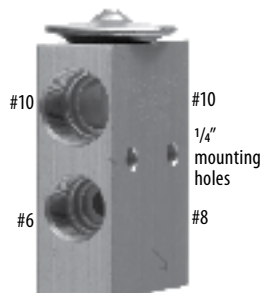

**71R8400** RD-5-7155-0P

With 7/16" Schrader Port  
**Inlet:** #6 (3/8") Female O-Ring  
**Outlet:** #10 (5/8") Female O-Ring  
**Evaporator Fittings**  
**In:** #8 (1/2") Female O-Ring  
**Out:** #8 (1/2") Female O-Ring  
**Superheat Rating:** 5°F  
**Pressure Limit:** 50 psig @85°F

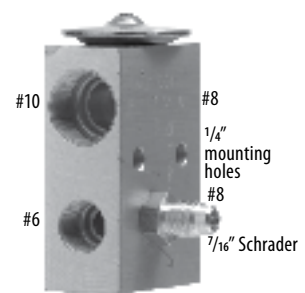

### FRAME FILTERS

**78R5236M** RD-5-10077-1P

9" x 9" x 5/8" thick



**78R5251\*** RD-3-6407-0P

13 1/8" wide x 5 1/4" high x 1 1/16" thick

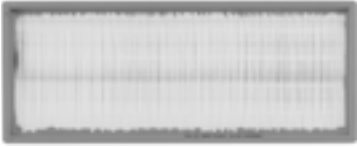

**78R5256M** RD-5-10075-1P

28 1/2" x 7 1/8" x 1/4" thick



All filters sold in packs of two except where noted with \*

### FITTING ADAPTER

**75R8520** RD-5-9156-0P

**Head Type E**  
 Vertical Male O-Ring  
 1" x 14



### HEATER CORE NIPPLE

**70R7100** RD-4130-1P

5/8" Hose to 5/8" Hose—Straight



### KNOBS

**71R4105** RD-5-8673-0P

10-32 Internal Threads  
 Shaft diameter: 1/4"



### LOUVERS

**72R3135** RD-5-10236-0P

3 1/2" Diffuser, 3 3/8" O.D., 3 1/4" mounting hole



**FITTINGS**

**Straight Splicer**

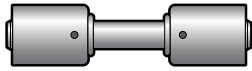

	Factory No.	Thread	Fitting Size	Hose Size	Port
<b>70R2016S</b>	RD-5-8267-0P	N/A	N/A	6 X 6	N/A
<b>70R2018S</b>	RD-5-8268-0P	N/A	N/A	8 X 8	N/A
<b>70R2011S</b>	RD-5-8265-0P	N/A	N/A	10 X 10	N/A
<b>70R2012S</b>	RD-5-8266-0P	N/A	N/A	12 X 12	N/A

**Straight Splicer**

Step-Up

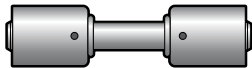

	Factory No.	Thread	Fitting Size	Hose Size	Port
<b>70R2036S</b>	RD-5-8274-0P	N/A	N/A	6 X 8	N/A
<b>70R2038S</b>	RD-5-12026-0P	N/A	N/A	8 X 10	N/A

**Straight Splicer**

With R134a Quick Disconnect Service Port

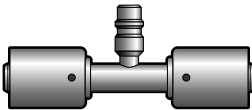

	Factory No.	Thread	Fitting Size	Hose Size	Port
<b>70R2071S</b>	RD-5-7058-0P	N/A	N/A	10 X 10	13mm
<b>70R2072S</b>	RD-5-7075-0P	N/A	N/A	12 X 12	13mm

**Tee Splicer**

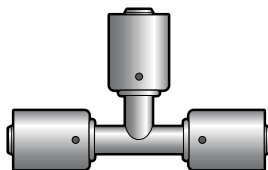

	Factory No.	Thread	Fitting Size	Hose Size	Port
<b>70R2406S</b>	RD-5-12032-0P	N/A	N/A	6 x 6 x 6	N/A
<b>70R2408S</b>	RD-5-12033-0P	N/A	N/A	8 x 8 x 8	N/A
<b>70R2402S</b>	RD-5-12035-0P	N/A	N/A	12 x 12 x 12	N/A

**90° Female Flare**

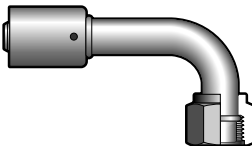

	Factory No.	Thread	Fitting Size	Hose Size	Port
<b>70R4298S</b>	RD-5-12044-0P	3/4" - 16	8	8	N/A

**90° Male O-Ring**

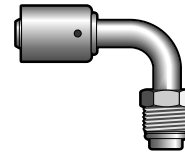

	Factory No.	Thread	Fitting Size	Hose Size	Port
<b>70R4396S</b>	RD-5-6944-0P	5/8" - 18	6	6	N/A

**Straight Female O-Ring**

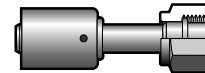

	Factory No.	Thread	Fitting Size	Hose Size	Port
<b>70R4406S</b>	RD-5-6838-0P	5/8" - 18	6	6	N/A
<b>70R4408S</b>	RD-5-6947-0P	3/4" - 16	8	8	N/A

**90° Female O-Ring**

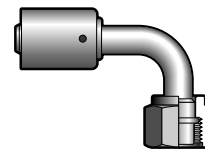

	Factory No.	Thread	Fitting Size	Hose Size	Port
<b>70R4496S</b>	RD-5-6945-0P	5/8" - 18	6	6	N/A
<b>70R4498S</b>	RD-5-6840-0P	3/4" - 16	8	8	N/A
<b>70R4491S</b>	RD-5-6956-0P	7/8" - 14	10	10	N/A

**Straight Female O-Ring**

Step-Up

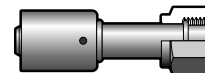

	Factory No.	Thread	Fitting Size	Hose Size	Port
<b>70R4606S</b>	RD-5-8283-0P	5/8" - 18	6	8	N/A
<b>70R4608S</b>	RD-5-8284-0P	3/4" - 16	8	10	N/A

**90° Female O-Ring**

Step-Up

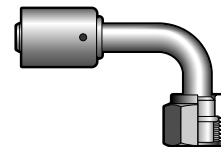

	Factory No.	Thread	Fitting Size	Hose Size	Port
<b>70R4696S</b>	RD-5-8286-0P	5/8" - 18	6	8	N/A
<b>70R4698S</b>	RD-5-8463-0P	3/4" - 16	8	10	N/A
<b>70R4691S</b>	RD-5-6978-0P	7/8" - 14	10	12	N/A

## PANCAKE FAN ASSEMBLIES

**73R8712**

**RD-5-14681-0P**

Single Speed Pusher  
12 Volt  
Rotates Counter Clockwise  
Permanent Magnet Motor  
mounted with Shroud & Fan  
**Dimensions:**  
12" diameter x 4" thick  
Height 12"

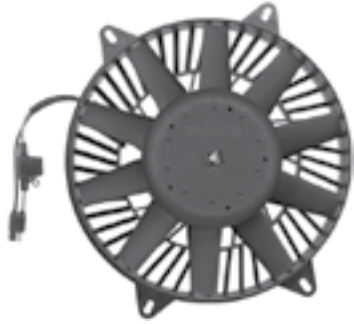

**73R8722**

**RD-5-14682-0P**

Single Speed Puller  
12 Volt  
Rotates Counter Clockwise  
Permanent Magnet Motor  
mounted with Shroud & Fan  
**Dimensions:**  
13" diameter x 2 1/2" thick  
Height 13"



## O-RINGS

**70R5056**

RD-5-3728-0M

**GREEN**  
#6



**70R5046**

RD-5-10942-0M

**BLUE**  
#6



GM CAPTIVE

**70R5058**

RD-5-3729-0M

**GREEN**  
#8



**70R5051**

RD-5-3730-0M

**GREEN**  
#10

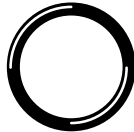

**70R5052**

RD-5-9061-0M

**GREEN**  
#12

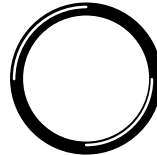

**70R5042**

RD-5-10943-0M

**BLACK**  
#12

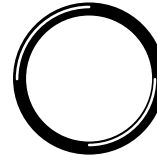

GM CAPTIVE

**70R5057**

RD-5-10085-0M

**GREEN**  
Expansion Valve  
Equalizer Tube



O-Rings ship 25 per package

## PRESSURE SWITCHES

**71R6050**

**RD-4191-0P**

3/8"-24-UNF-2A male threads O-Ring  
Normally open - closes at 27 PSIG



**71R6070**

**RD-5-5873-0P**

Type: High Side  
Fitting / Connector: 1/4" female flare / two conductor bare wire  
Normally Closed – Closes at 210 PSI – Opens at 340 PSI





**RECEIVER DRIERS**

**74R0462**

**RD-5-7064-1P**

2 1/2" diameter x 9 5/16" long  
#6 Male O-Ring Inline  
High Capacity



**74R0480**

**RD-5-14686-0P**

2 3/4" diameter x 8 1/4" long  
#8 Male O-Ring Inline  
With moisture indicator



**74R0485**

**RD-5-14687-0P**

3" diameter x 10" long  
#8 Flare O-Ring Inline



**74R0475**

**RD-5-14685-1P**

3" diameter x 8 1/4" long



**74R0907**

**RD-5-4950-1P**

2 1/2" diameter x 8" long  
Freightliner A22-14425-001  
#6 Male O-Ring  
IHC/Navistar 1691709-C91  
Fuse  
Side Port



**74R1756**

**RD-5-3593-0P**

2 3/4" diameter x 10" long  
#6 Male O-Ring  
High Capacity  
Pressure Relief  
Side Port



**74R2106**

**RD-4160-1P**

Includes Low Pressure Switch  
2 3/4" diameter x 10" long  
#6 Male O-Ring

High Capacity  
Low Pressure /  
Pressure Relief  
Side Port

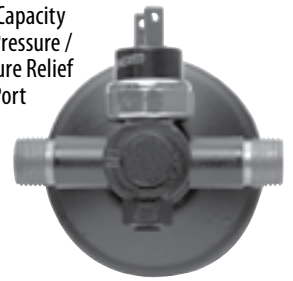

**RED DOT REFRIGERANT HOSE**

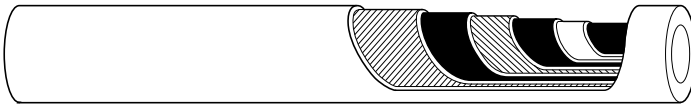

RED DOT INTERNAL NYLON BARRIER

**Reduced Ozone Permeation.**

Internal Nylon Barrier hose is specifically designed to reduce the permeation level of ozone-depleting refrigerant and chemicals in heavy duty air conditioning systems.

**"Universal" Compatibility.**

Extensive testing has shown Red Dot Refrigerant Hose to be compatible with today's state-of-the-art refrigerants, including R-12, R-134a and Ternary Blends.

Part No.	Factory No.	SAE Hose Size	I.D.	Max. O.D.	Length
<b>78R0456</b>	RD-5-5006-600P	#6	5/16"	3/4"	50 ft. Box
<b>78R0456SP</b>	RD-5-5006-0P	#6	5/16"	3/4"	825 ft. Spool
<b>78R0458</b>	RD-5-5008-600P	#8	13/32"	29/32"	50 ft. Box
<b>78R0458SP</b>	RD-5-5008-0P	#8	13/32"	29/32"	725 ft. Spool
<b>78R0451</b>	RD-5-5010-600P	#10	1/2"	1"	50 ft. Box
<b>78R0451SP</b>	RD-5-5010-0P	#10	1/2"	1"	700 ft. Spool
<b>78R0452</b>	RD-5-5012-600P	#12	5/8"	1 1/8"	50 ft. Box
<b>78R0452SP</b>	RD-5-5012-0P	#12	5/8"	1 1/8"	525 ft. Spool

**For use with ATCO Bead Lock or "Bubble Style" Crimp Fittings**

## RELAYS

**71R1702**

RD-5-4408-0P

 12V Relay, 30/20 amps,  
 SPDT, 5 terminals Bosch type

**71R1704**

RD-5-4417-0P

 24V Relay, 20/10 amps,  
 SPDT, 5 terminals Bosch type

## RESISTORS

**71R1457**

RD-5-10341-0P

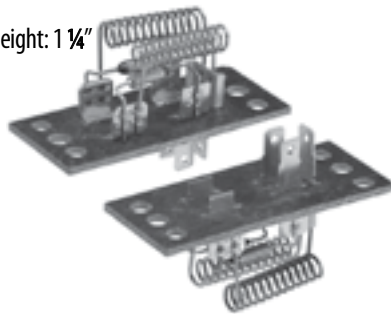
 3 Terminals (1/4" blade) – 3 Speeds  
 Bakelite base: 3" x 1 1/4" x .10" thick, Height: 1 1/4"

**71R1463**

RD-5-10441-0P

 3 Terminals (1/4" blade) – 3 Speeds  
 Bakelite base: .10" thick

## REFRIGERANT SOLENOID VALVE (Liquid Line)

**71R9002**

RD-4188-0P

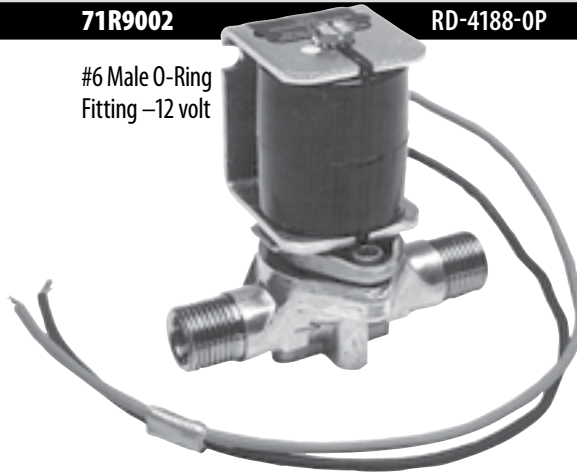
 #6 Male O-Ring  
 Fitting –12 volt

**SWITCHES**

**71R1150**

**RD-5-3646-0P**

3 speed, Long Shaft  
DP3T  
4-position  
5 terminals  
25 amps



Mounting hole: .442" x .385" - "D" hole

**71R1160**

**RD-5-9833-0P**

3 speed, Short Shaft  
DP3T  
4-position  
5 terminals  
25 amps

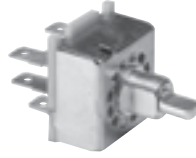

Mounting hole: .442" x .385" - "D" hole

**71R1165**

**RD-5-3779-0P**

3 speed (low, medium, high)  
DP3T,  
5-position,  
5 terminals  
15 amps



Mounting hole: .442" x .385" - "D" hole

**THERMOSTATS**

**71R2250**

**RD-4125-36P**

Capillary Length: 36"  
Type: Variable  
Temp. Range: 34°- 52°F  
Clutch Cycle Range: 5°F



**71R3160**

**RD-5-8938-0P**

Capillary Length: 12"  
Type: Fixed  
Temp. Range: 31°- 40°F  
Clutch Cycle Range: 8°F



**71R2300**

**RD-4125-48P**

Capillary Length: 48"  
Type: Variable  
Temp. Range: 34°- 52°F  
Clutch Cycle Range: 5°F



**71R3220**

**RD-5-10335-0P**

Mounting hole spacing: 2 1/8"  
Capillary Length: 21"  
Type: Fixed (side mount)  
Temp. Range: 31°- 40°F



**WATER VALVE**

**72R5500**

**RD-5-5192-0P**

5/8" Hose to 5/8" Hose  
Manual Open & Close



